

1

Isometric - Detail Map - Tactile Formed Aluminum™ Metal Cladding
 Scale : Not to Scale

SHEET NO. M-00	REVISIONS				PROJECT#	ARCHITECT	CLIENT
SCALE AS NOTED	REV	DESCRIPTION	DATE	APPROVED	Tactile Formed Aluminum™ Metal Cladding Details Ventilated Rainscreen		
DRAWN BY AM							
APPROVED BY SE							
ISSUE DATE 05/27/2020							

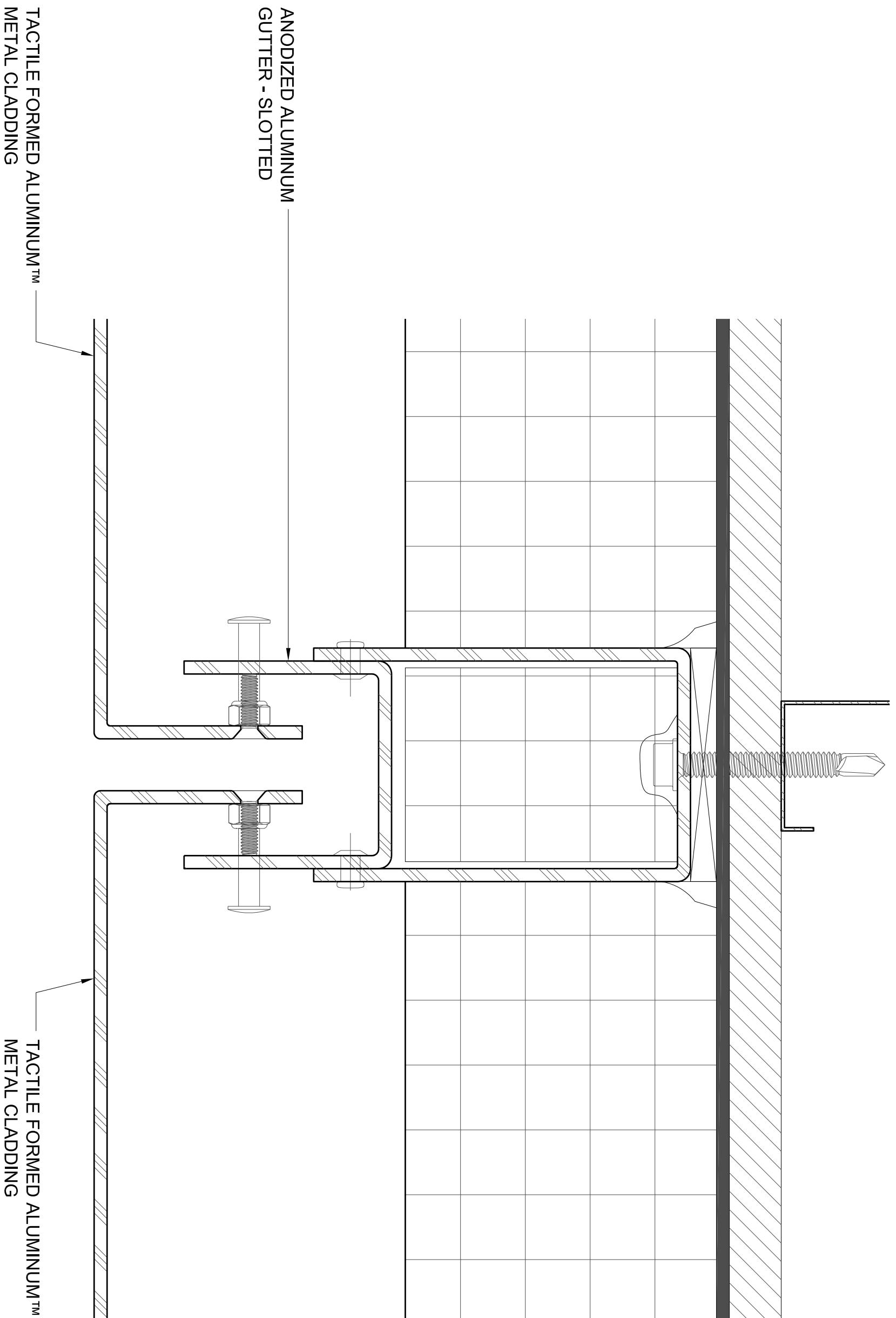

1 Plan - Typical Vertical Joint - Tactile Formed Aluminum™ Metal Cladding

Scale : 1=1

SHEET NO. M-01	REVISIONS				PROJECT#	ARCHITECT	CLIENT
SCALE AS NOTED	REV	DESCRIPTION	DATE	APPROVED	Tactile Formed Aluminum™ Metal Cladding Details Ventilated Rainscreen		
DRAWN BY AM							
APPROVED BY SE							
ISSUE DATE 05/27/2020							

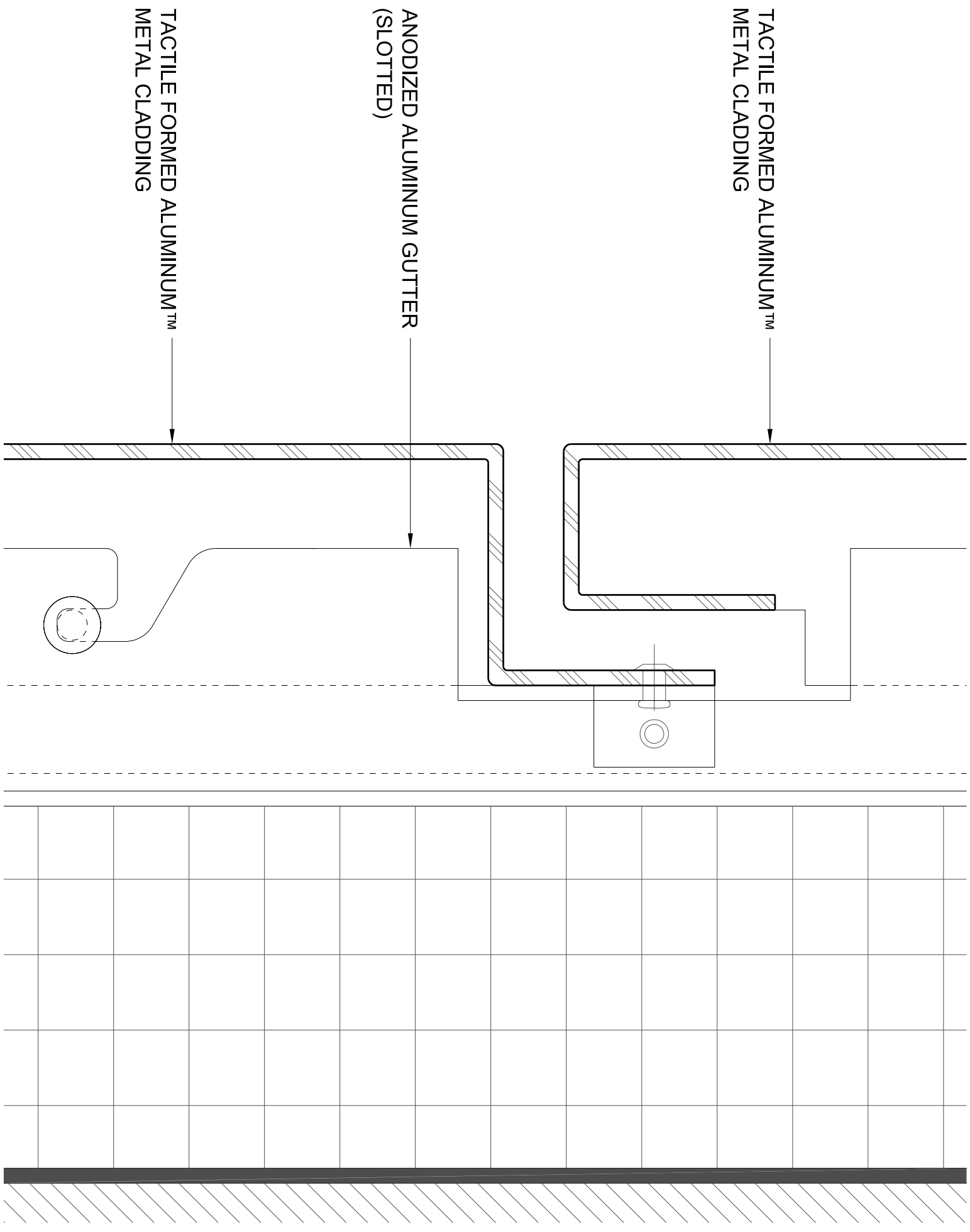

1

Section - Typical Horizontal Joint - Tactile Formed Aluminum™ Metal Cladding
 Scale : 1=1

SHEET NO. M-02	REVISIONS				PROJECT#	ARCHITECT	CLIENT
SCALE AS NOTED	REV	DESCRIPTION	DATE	APPROVED	Tactile Formed Aluminum™ Metal Cladding Details Ventilated Rainscreen		
DRAWN BY AM							
APPROVED BY SE							
ISSUE DATE 05/27/2020							

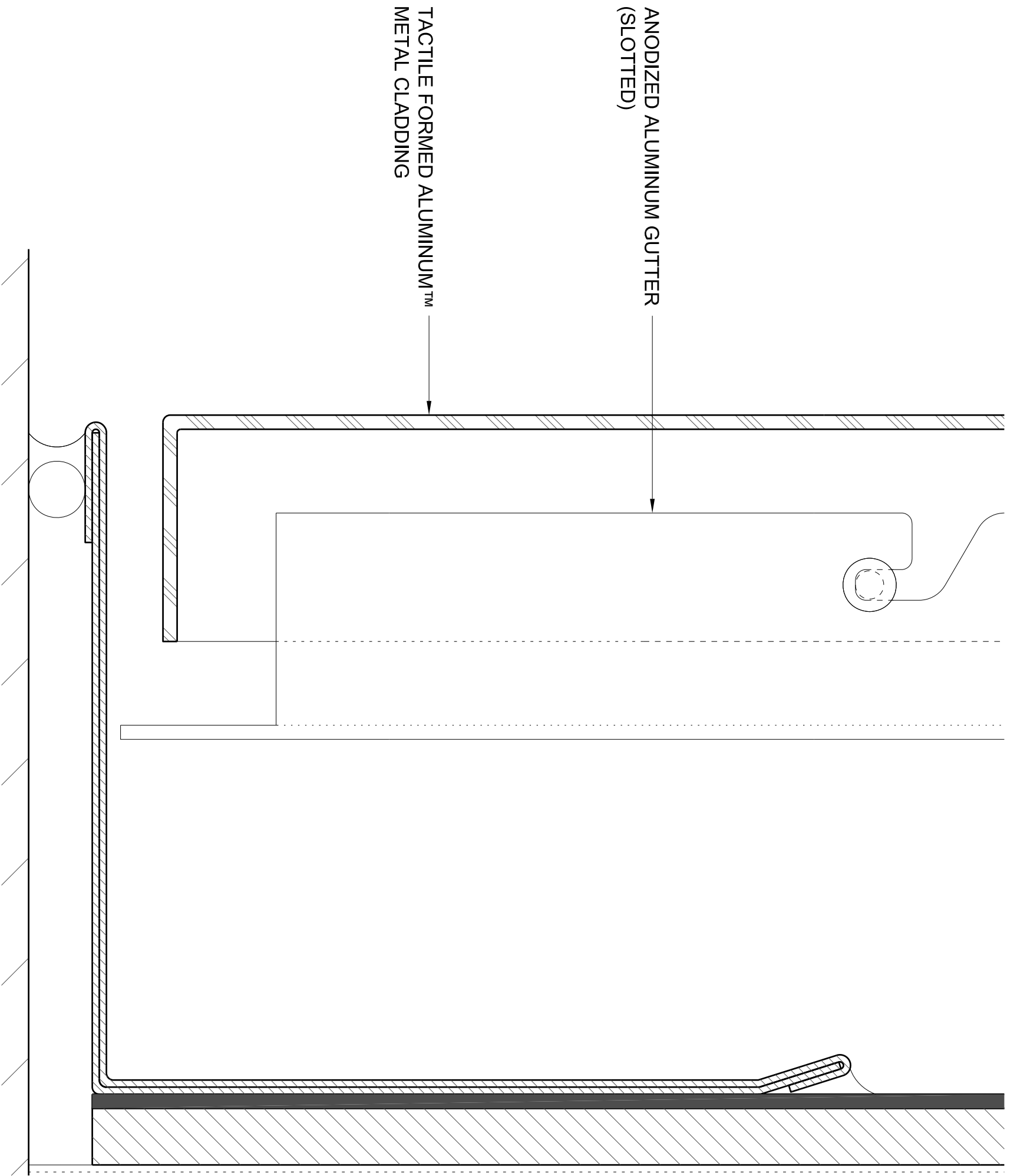

1

Section - Sill Detail - Tactile Formed Aluminum™ Metal Cladding
Scale : 1=1

SHEET NO. M-03	REVISIONS				PROJECT#	ARCHITECT	CLIENT	
SCALE AS NOTED	REV	DESCRIPTION	DATE	APPROVED	Tactile Formed Aluminum™ Metal Cladding Details Ventilated Rainscreen			
DRAWN BY AM								
APPROVED BY SE								
ISSUE DATE 05/27/2020								

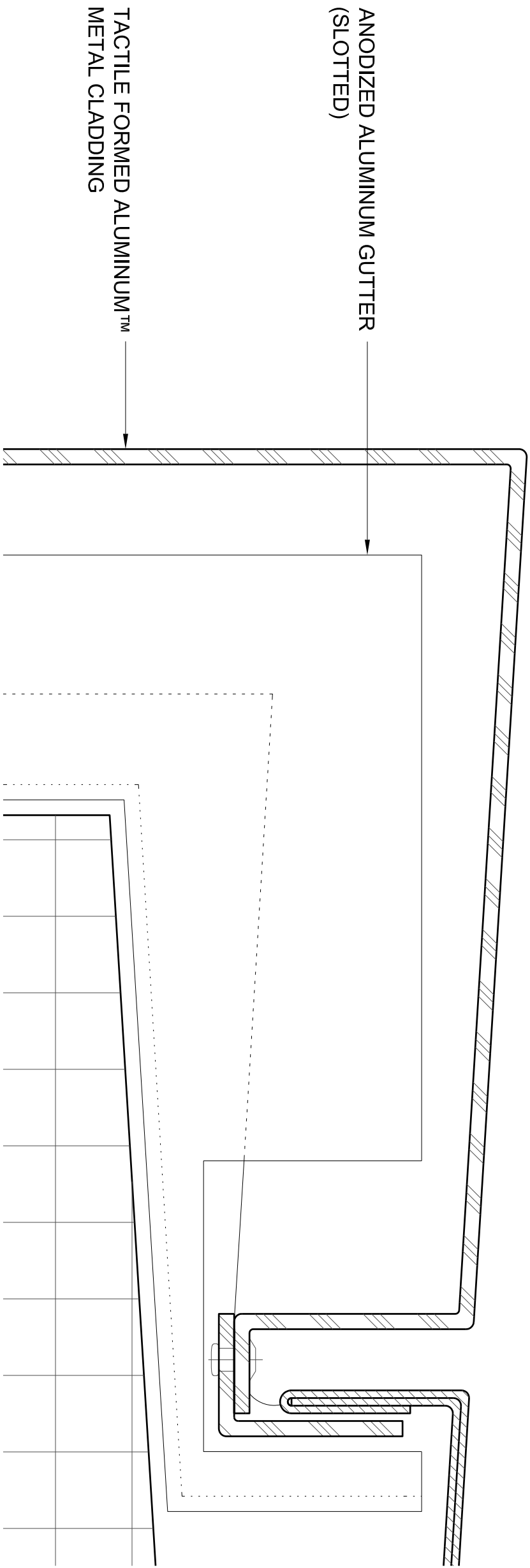

ANODIZED ALUMINUM GUTTER
(SLOTTED)

TACTILE FORMED ALUMINUM™
METAL CLADDING

1

Section - Parapet Return Detail - Tactile Formed Aluminum™ Metal Cladding
Scale : 1=1

SHEET NO. M-04	REVISIONS				PROJECT#	ARCHITECT	CLIENT
SCALE AS NOTED	REV	DESCRIPTION	DATE	APPROVED	Tactile Formed Aluminum™ Metal Cladding Details Ventilated Rainscreen		
DRAWN BY AM							
APPROVED BY SE							
ISSUE DATE 05/27/2020							

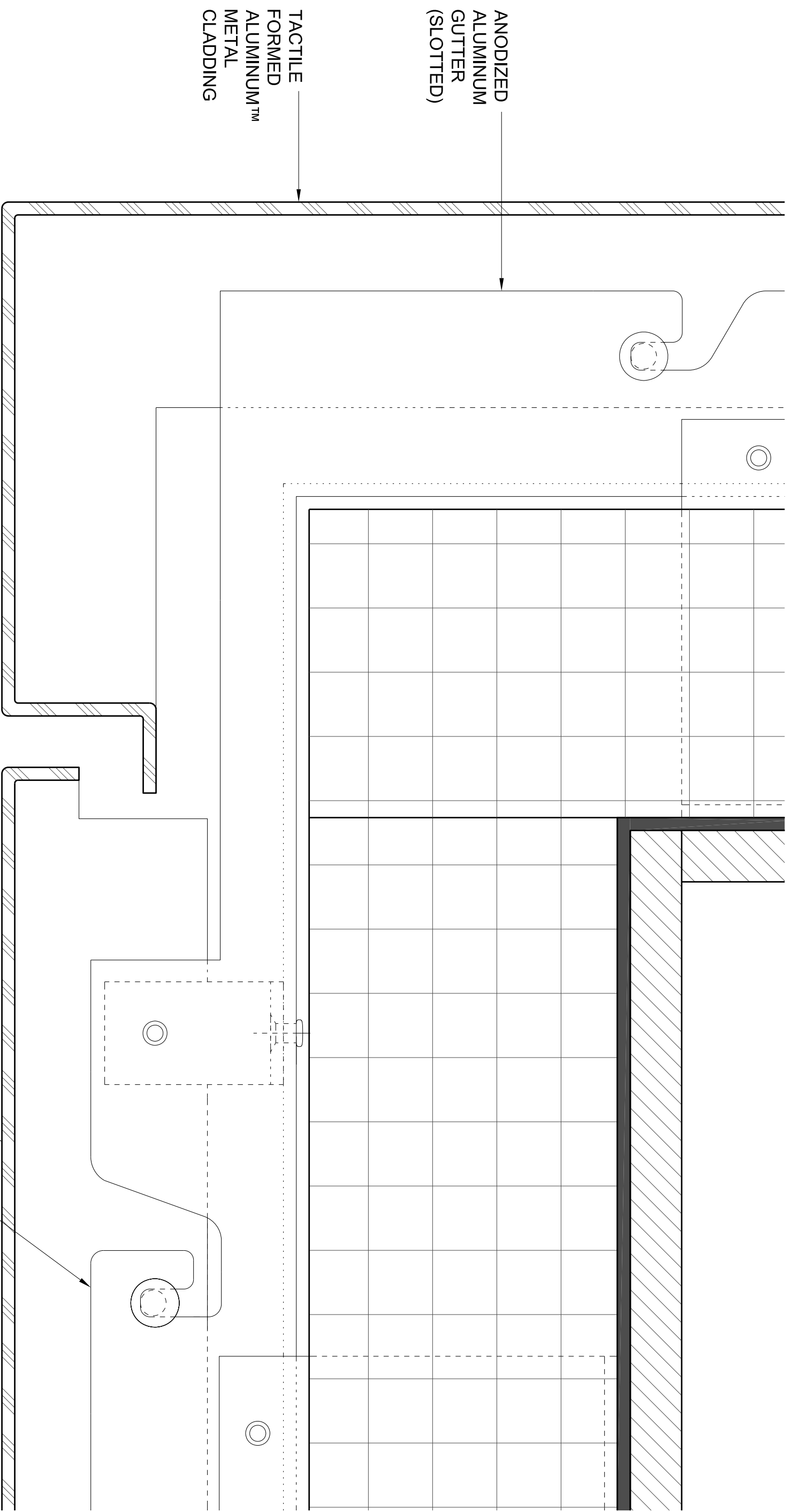

ANODIZED ALUMINUM GUTTER (SLOTTED)

TACTILE FORMED ALUMINUM™ METAL CLADDING

TACTILE FORMED ALUMINUM™ METAL CLADDING

ANODIZED ALUMINUM GUTTER (SLOTTED)

1

Section - Typical Soffit Detail - Tactile Formed Aluminum™ Metal Cladding
Scale : 1=1

SHEET NO. M-05	REVISIONS				PROJECT#	ARCHITECT	CLIENT
SCALE AS NOTED	REV	DESCRIPTION	DATE	APPROVED	Tactile Formed Aluminum™ Metal Cladding Details Ventilated Rainscreen		
DRAWN BY AM							
APPROVED BY SE							
ISSUE DATE 05/27/2020							

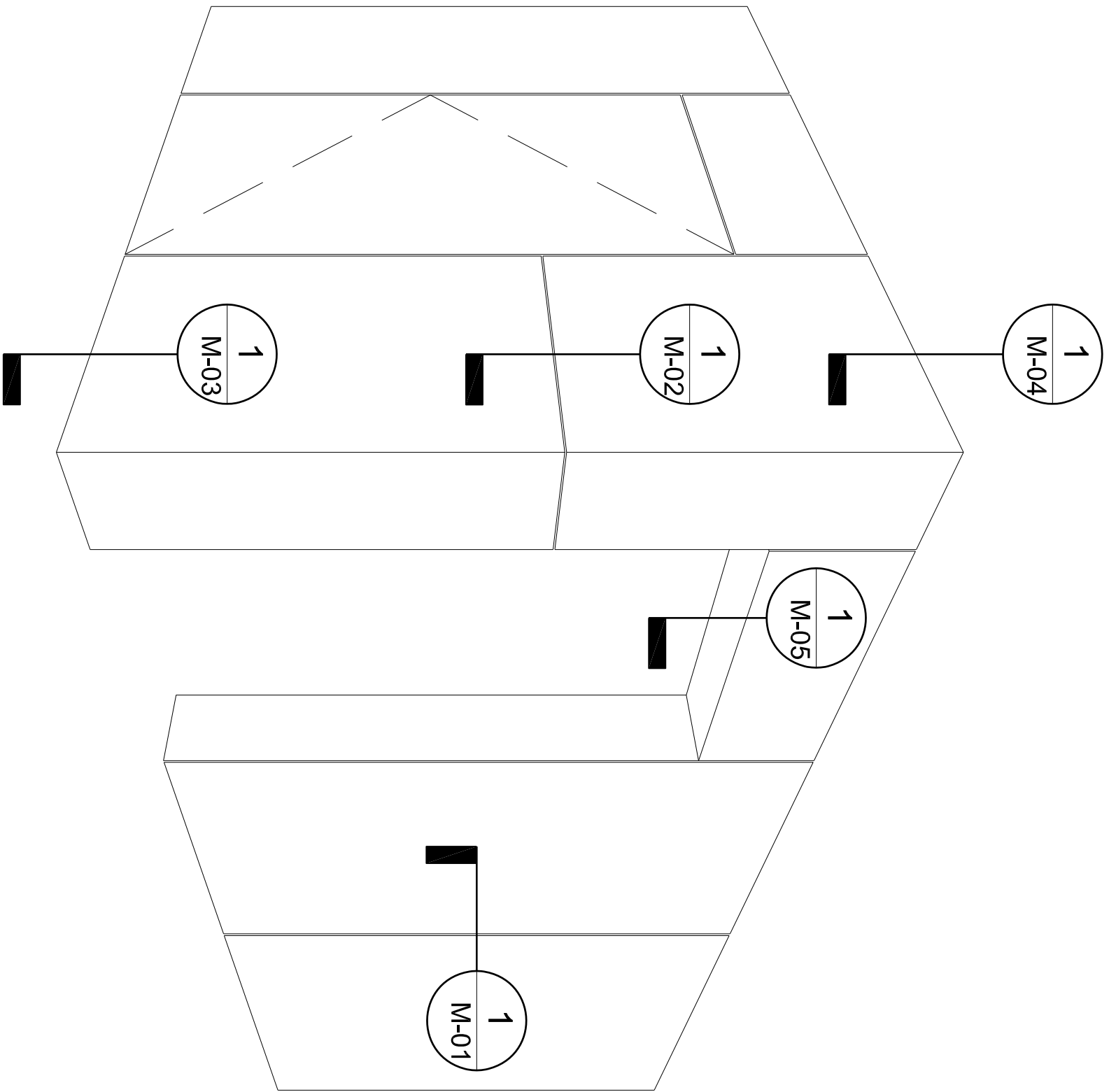

1

Isometric - Detail Map - Tactile Formed Aluminum™ Metal Cladding
 Scale : Not to Scale

SHEET NO. M-00	REVISIONS				PROJECT#	ARCHITECT	CLIENT
SCALE AS NOTED	REV	DESCRIPTION	DATE	APPROVED	Tactile Formed Aluminum™ Metal Cladding Details Wet Sealed Cladding		
DRAWN BY AM							
APPROVED BY SE							
ISSUE DATE 05/27/2020							

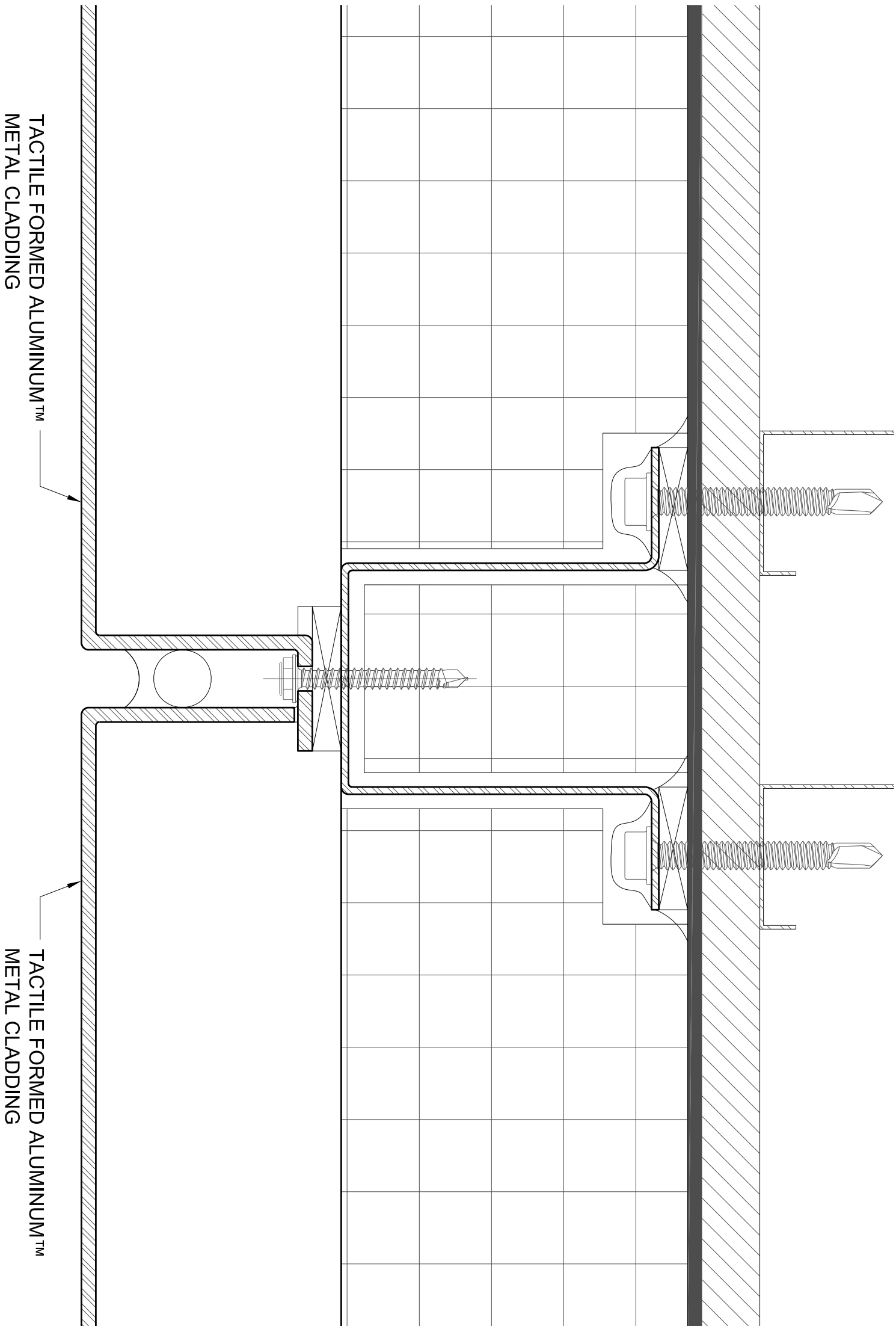

1 Plan - Typical Vertical Joint - Tactile Formed Aluminum™ Metal Cladding

Scale : 1=1

SHEET NO. M-01	REVISIONS				PROJECT#	ARCHITECT	CLIENT
SCALE AS NOTED	REV	DESCRIPTION	DATE	APPROVED	Tactile Formed Aluminum™ Metal Cladding Details Wet Sealed Cladding		
DRAWN BY AM							
APPROVED BY SE							
ISSUE DATE 05/27/2020							

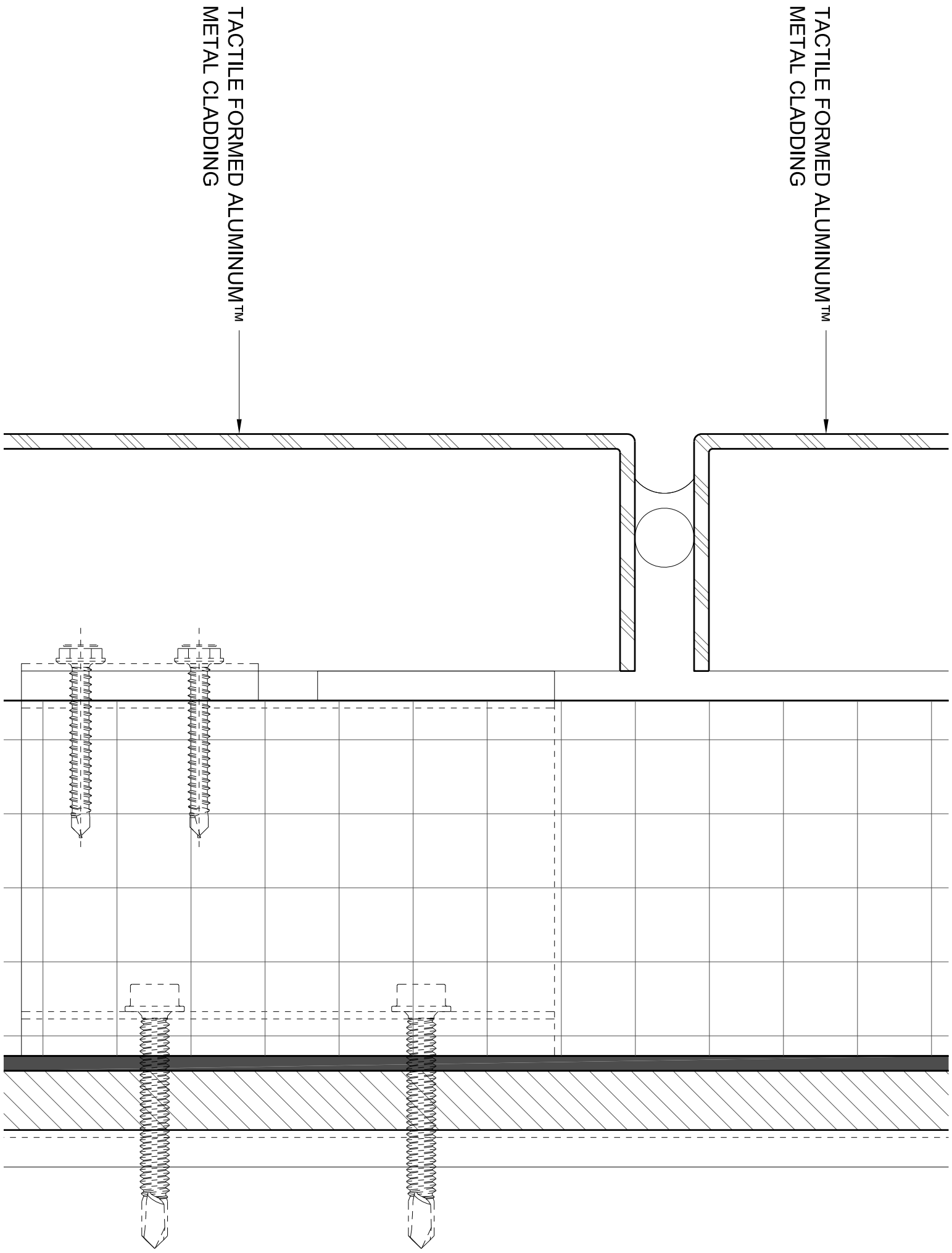

TACTILE FORMED ALUMINUM™
METAL CLADDING

TACTILE FORMED ALUMINUM™
METAL CLADDING

1

Section - Typical Horizontal Joint - Tactile Formed Aluminum™ Metal Cladding
Scale : 1=1

SHEET NO. M-02	REVISIONS				PROJECT#	ARCHITECT	CLIENT
SCALE AS NOTED	REV	DESCRIPTION	DATE	APPROVED	Tactile Formed Aluminum™ Metal Cladding Details Wet Sealed Cladding		
DRAWN BY AM							
APPROVED BY SE							
ISSUE DATE 05/27/2020							

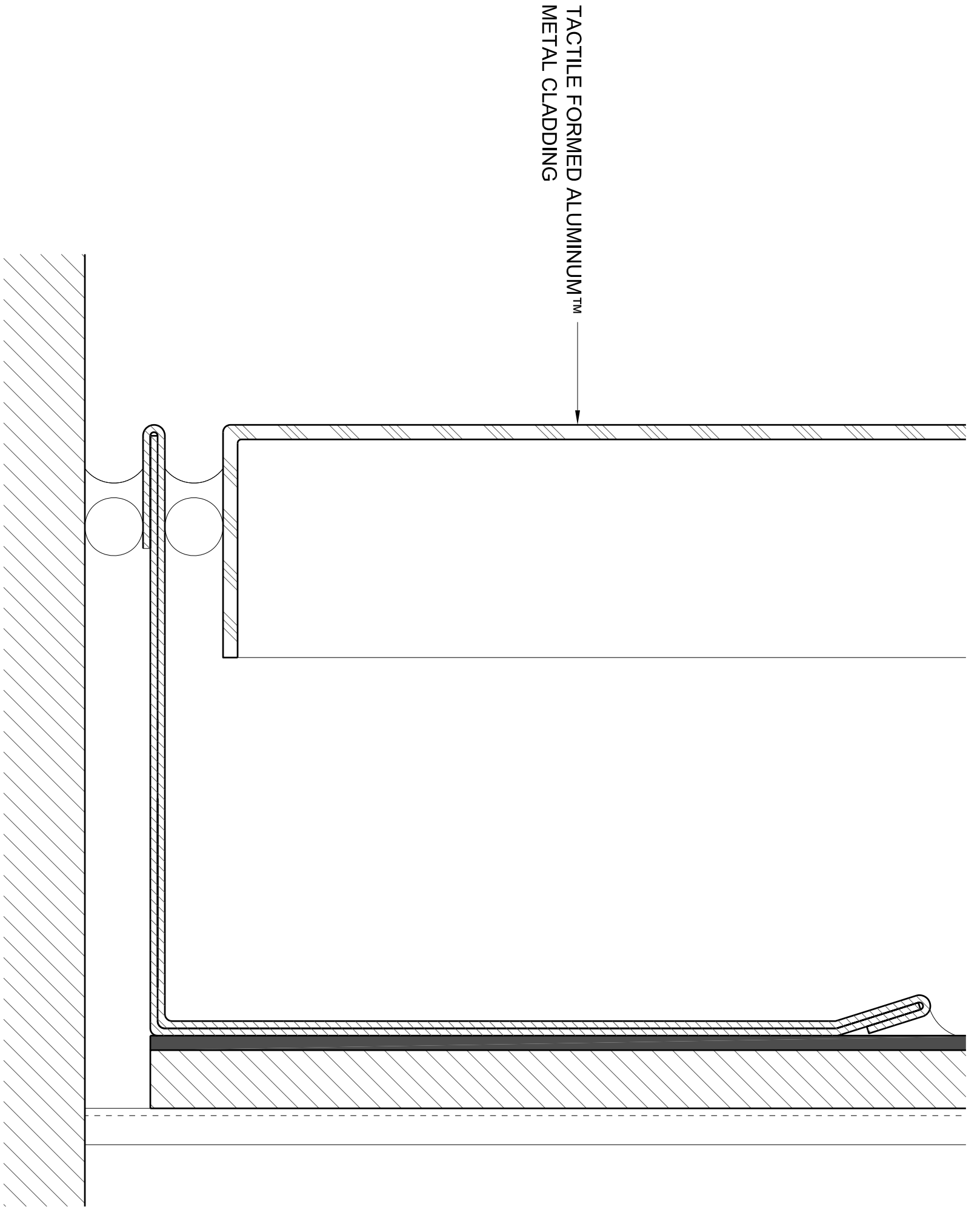

1

Section - Sill Detail - Tactile Formed Aluminum™ Metal Cladding
Scale : 1=1

SHEET NO. M-03	REVISIONS				PROJECT#	ARCHITECT	CLIENT
SCALE AS NOTED	REV	DESCRIPTION	DATE	APPROVED	Tactile Formed Aluminum™ Metal Cladding Details Wet Sealed Cladding		
DRAWN BY AM							
APPROVED BY SE							
ISSUE DATE 05/27/2020							

TACTILE FORMED ALUMINUM™
METAL CLADDING

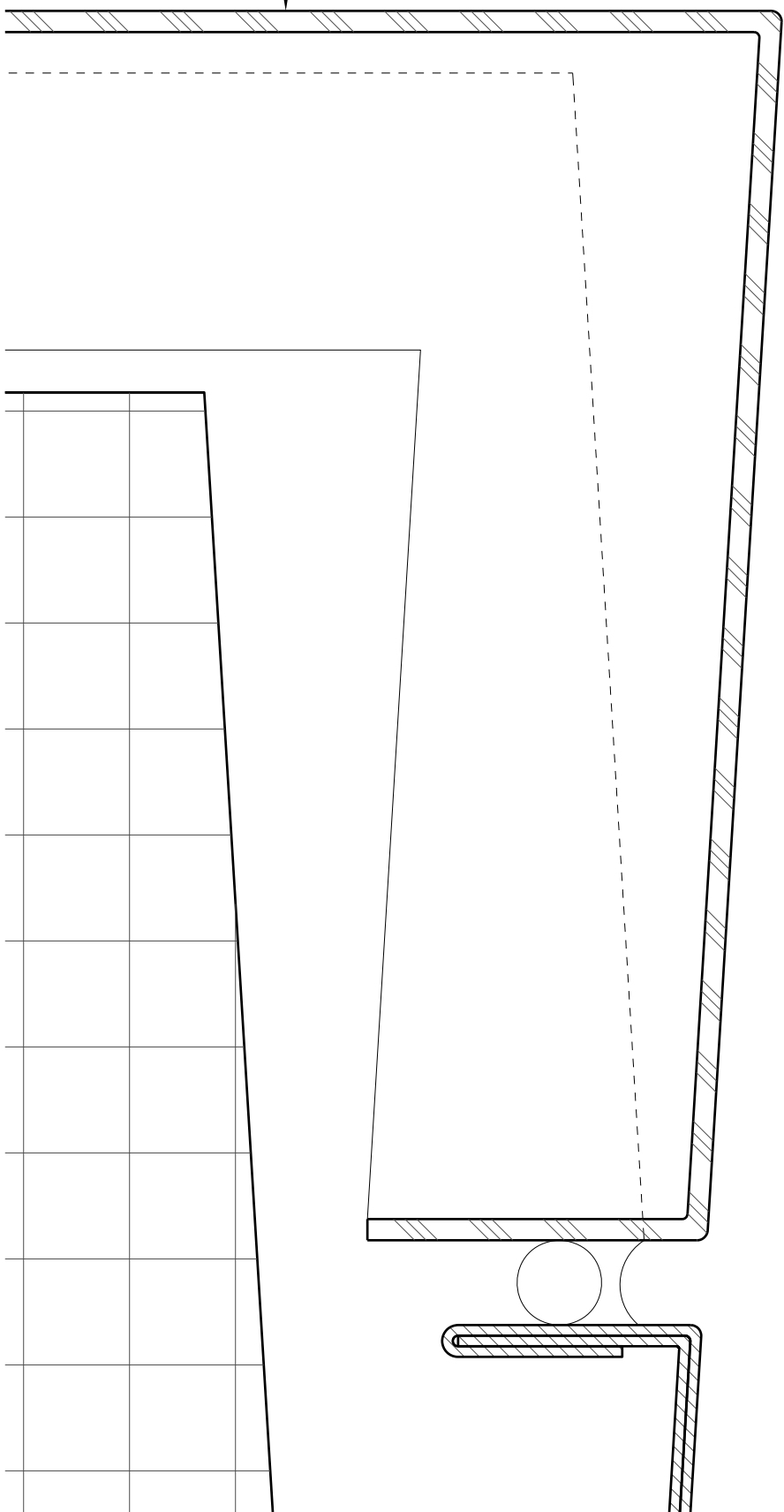

1

Section - Parapet Return Detail - Tactile Formed Aluminum™ Metal Cladding
Scale : 1=1

SHEET NO. M-04	REVISIONS				PROJECT#	ARCHITECT	CLIENT
SCALE AS NOTED	REV	DESCRIPTION	DATE	APPROVED	Tactile Formed Aluminum™ Metal Cladding Details Wet Sealed Cladding		
DRAWN BY AM							
APPROVED BY SE							
ISSUE DATE 05/27/2020							

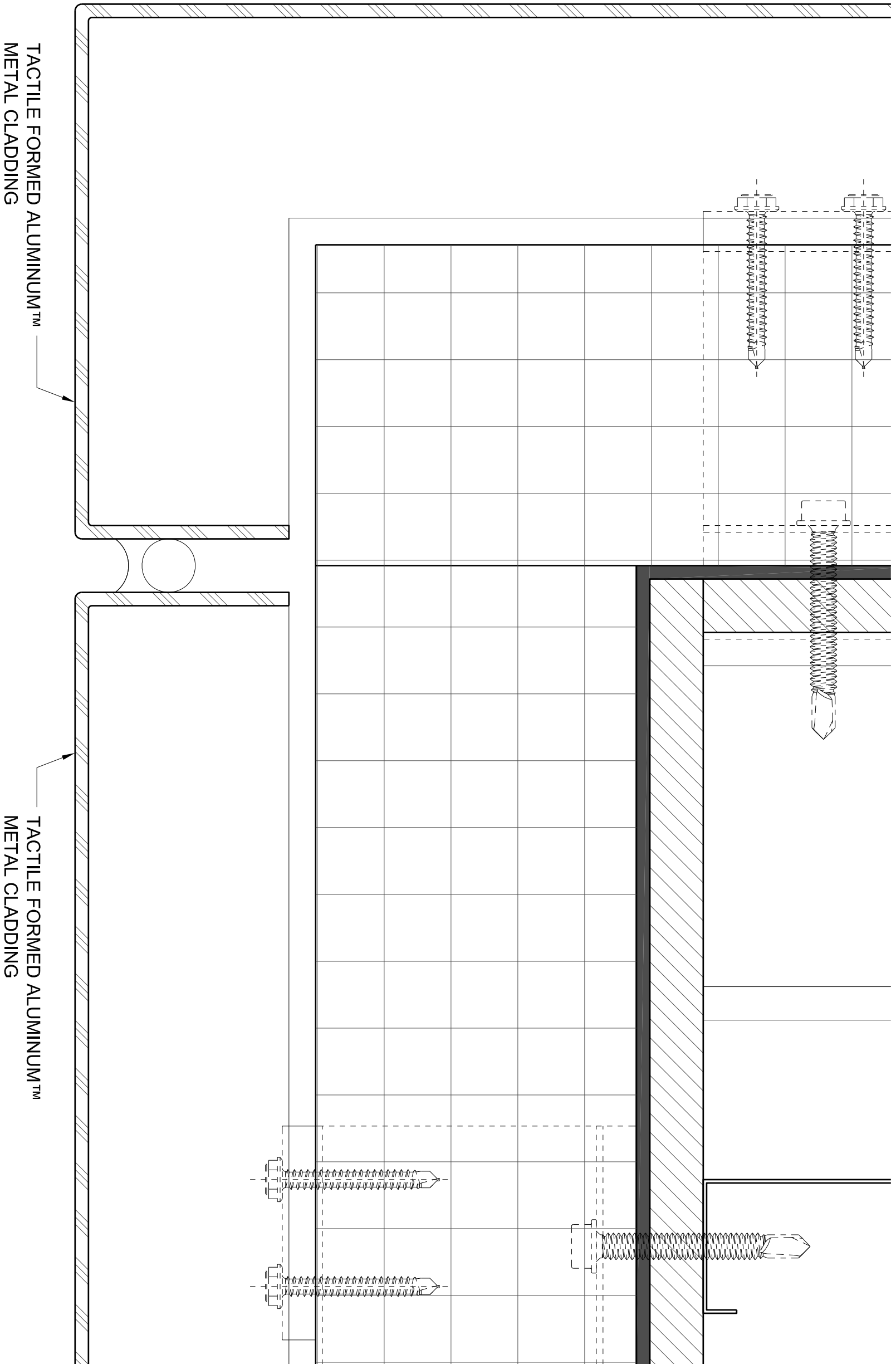

TACTILE FORMED ALUMINUM™
METAL CLADDING

TACTILE FORMED ALUMINUM™
METAL CLADDING

1

Section - Typical Soffit Detail - Tactile Formed Aluminum™ Metal Cladding
Scale : 1=1

SHEET NO. M-05	REVISIONS				PROJECT#	ARCHITECT	CLIENT
SCALE AS NOTED	REV	DESCRIPTION	DATE	APPROVED	Tactile Formed Aluminum™ Metal Cladding Details Wet Sealed Cladding		
DRAWN BY AM							
APPROVED BY SE							
ISSUE DATE 05/27/2020							

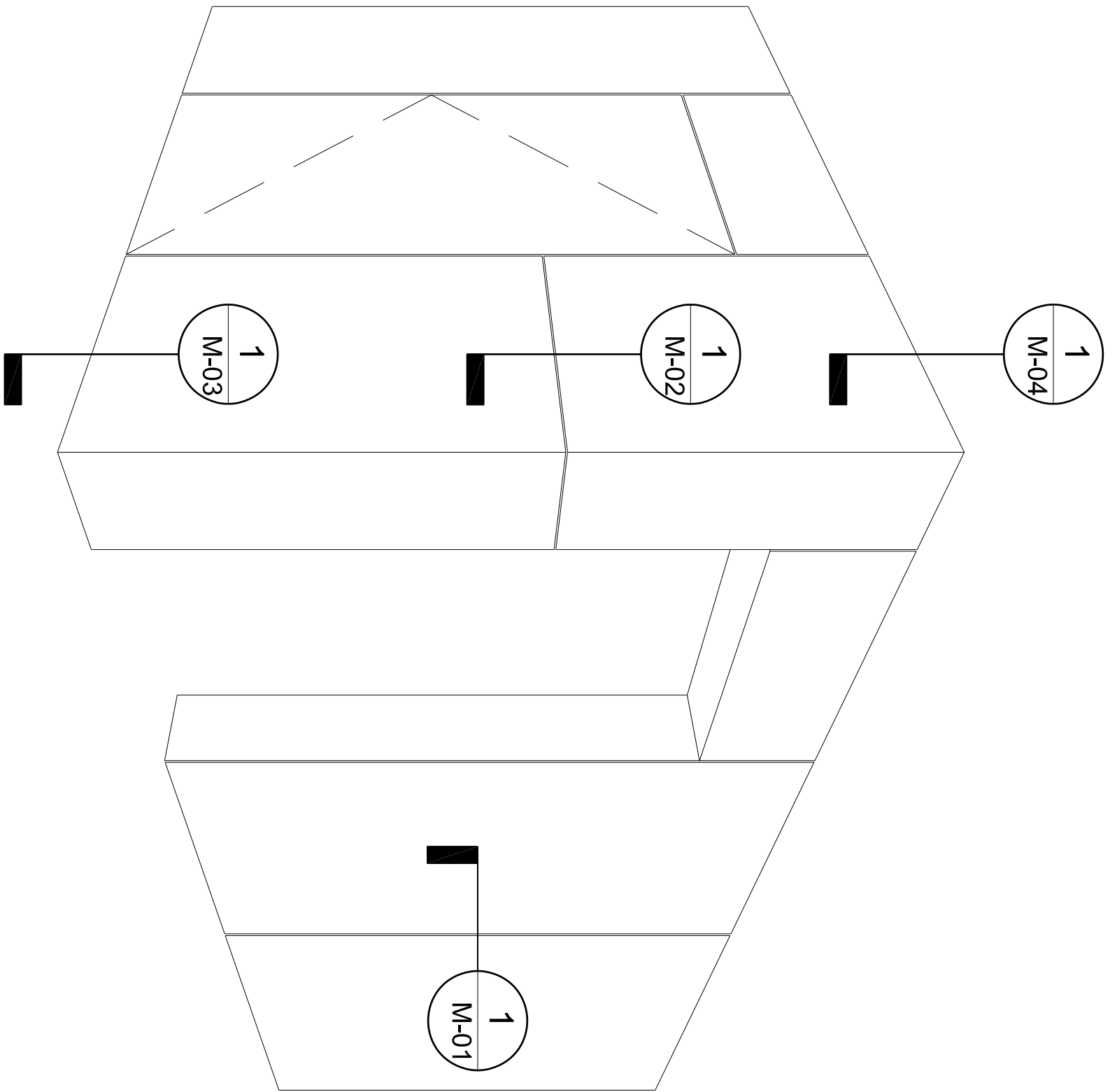

1

Isometric - Detail Map - Tactile Formed Aluminum™ Metal Cladding
 Scale : Not to Scale

SHEET NO. M-00	REVISIONS				PROJECT#	ARCHITECT	CLIENT
SCALE AS NOTED	REV	DESCRIPTION	DATE	APPROVED	Tactile Formed Aluminum™ Metal Cladding Details Interior Cladding		
DRAWN BY AM							
APPROVED BY SE							
ISSUE DATE 05/27/2020							

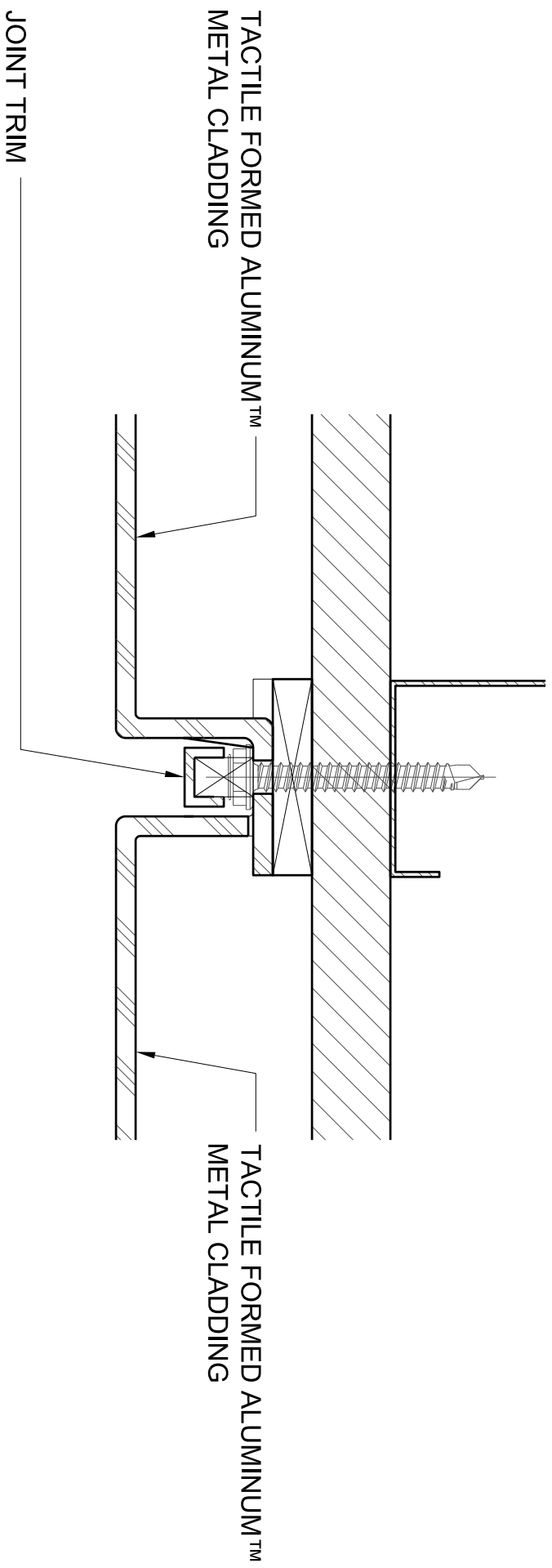

1

Plan - Typical Vertical Joint - Tactile Formed Aluminum™ Metal Cladding
Scale : 1=1

SHEET NO.	M-01	REVISIONS				PROJECT#	ARCHITECT	CLIENT
SCALE	AS NOTED	REV	DESCRIPTION	DATE	APPROVED	Tactile Formed Aluminum™ Metal Cladding Details Interior Cladding		
DRAWN BY	AM							
APPROVED BY	SE							
ISSUE DATE	05/27/2020							

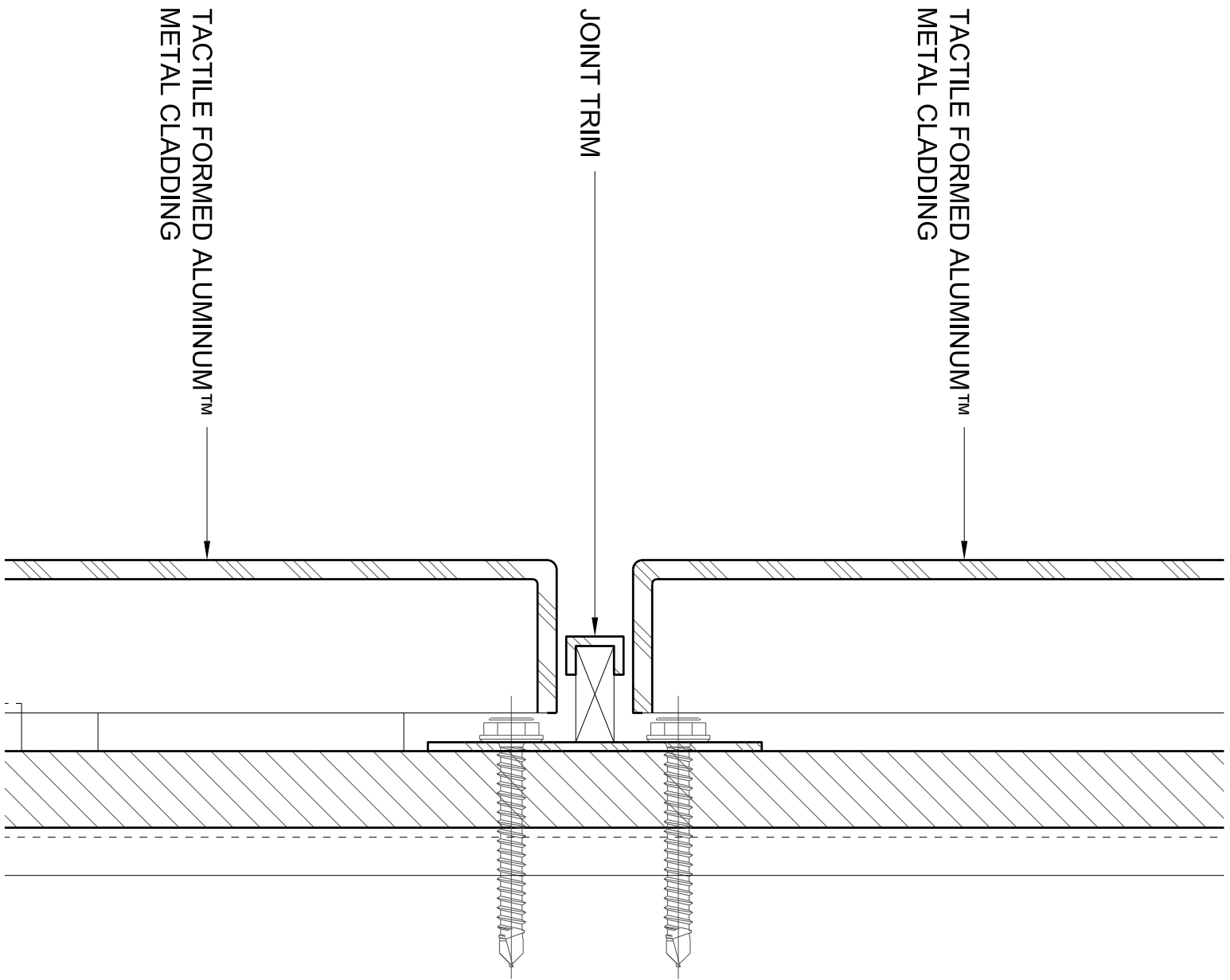

1

Section - Typical Horizontal Joint - Tactile Formed Aluminum™ Metal Cladding
 Scale : 1=1

SHEET NO. M-02	REVISIONS				PROJECT#	ARCHITECT	CLIENT
SCALE AS NOTED	REV	DESCRIPTION	DATE	APPROVED	Tactile Formed Aluminum™ Metal Cladding Details Interior Cladding		
DRAWN BY AM							
APPROVED BY SE							
ISSUE DATE 05/27/2020							

TACTILE FORMED ALUMINUM™
METAL CLADDING

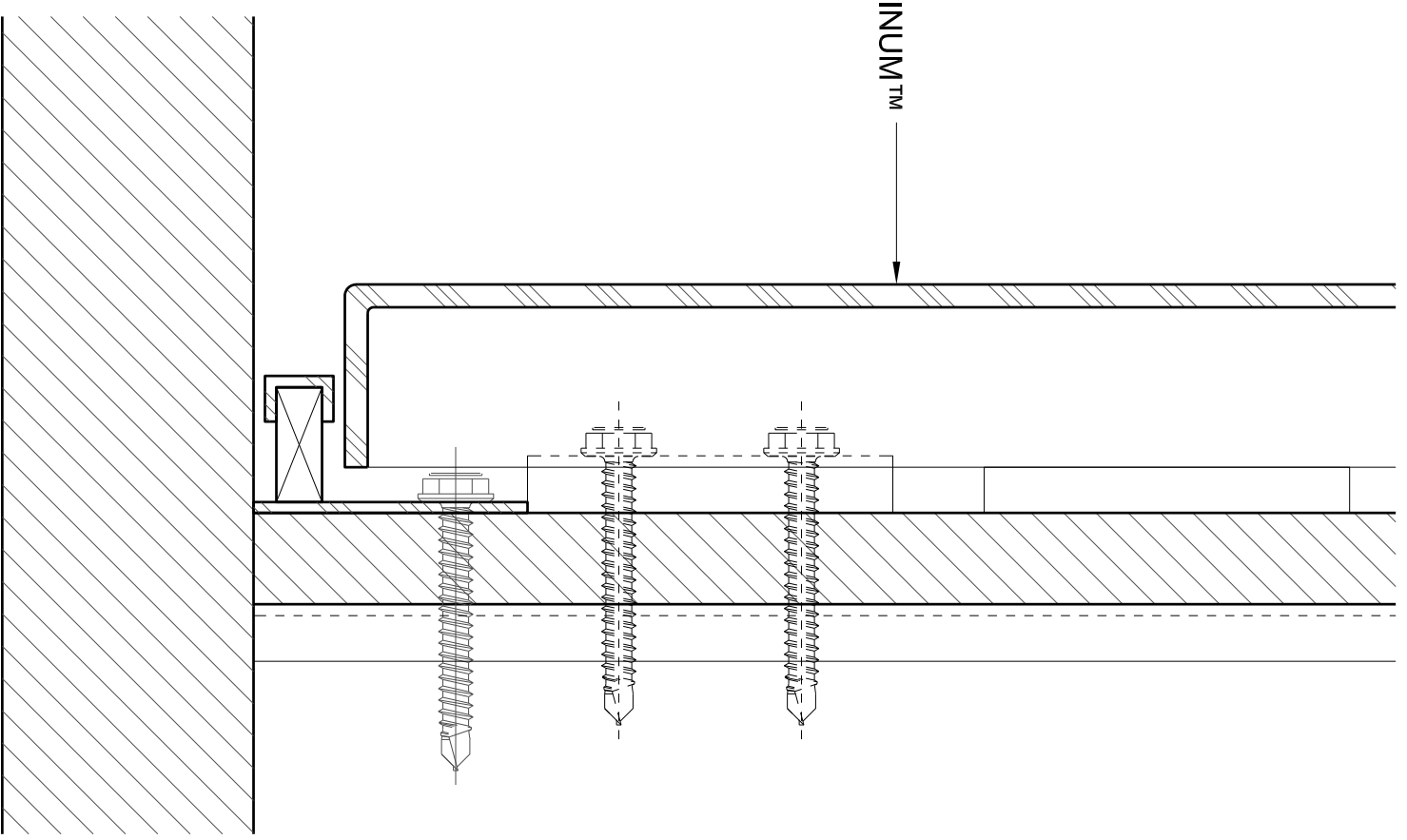

1

Section - Sill Detail - Tactile Formed Aluminum™ Metal Cladding
Scale : 1=1

SHEET NO.	REVISIONS				PROJECT#	ARCHITECT	CLIENT
SCALE	REV	DESCRIPTION	DATE	APPROVED	Tactile Formed Aluminum™ Metal Cladding Details Interior Cladding		
M-03							
AS NOTED							
05/27/2020							
DRAWN BY							
APPROVED BY							

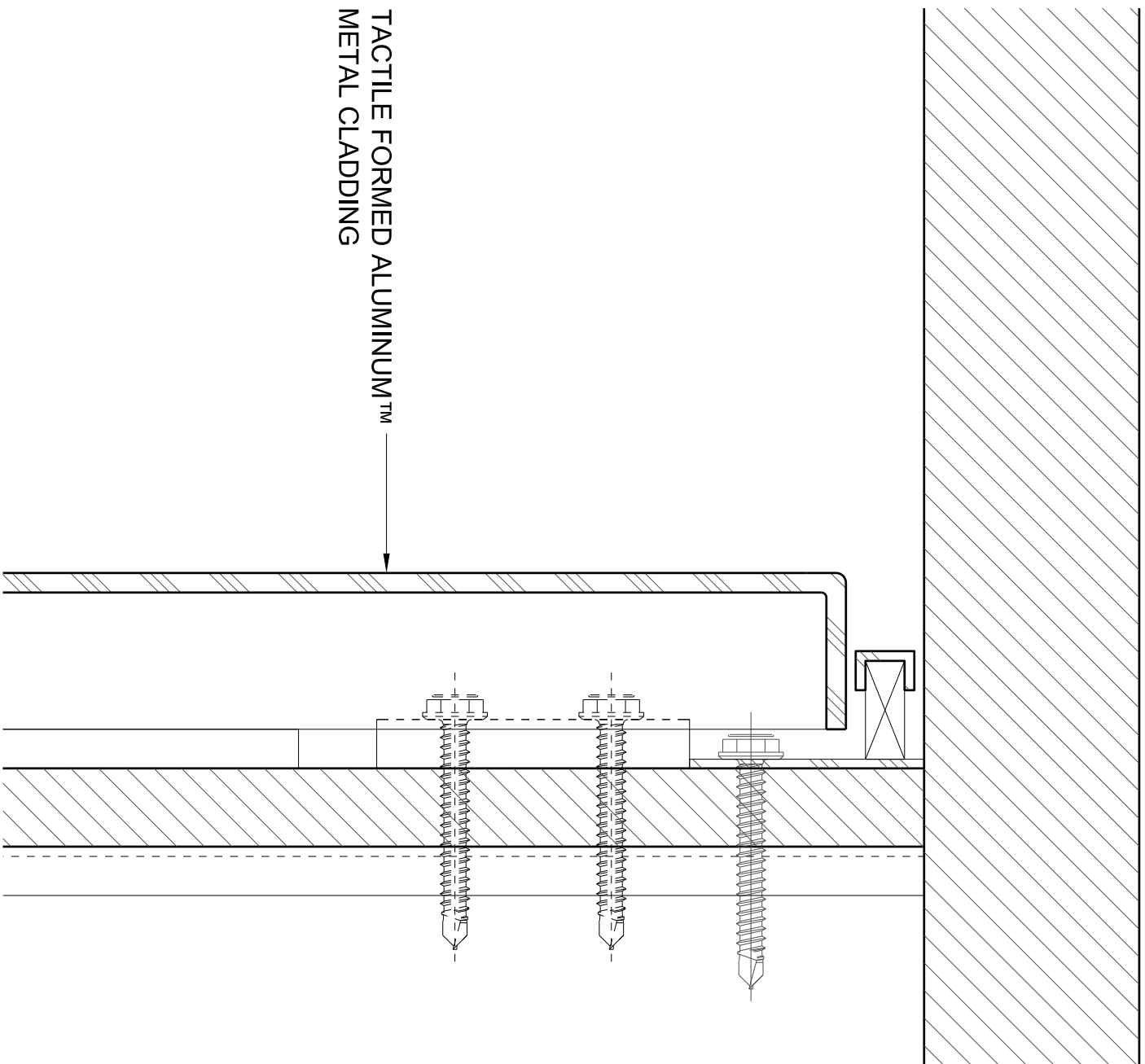

TACTILE FORMED ALUMINUM™
METAL CLADDING

1

Section - Parapet Return Detail - Tactile Formed Aluminum™ Metal Cladding
Scale : 1=1

SHEET NO.	REVISIONS				PROJECT#	ARCHITECT	CLIENT
M-04	REV	DESCRIPTION	DATE	APPROVED	Tactile Formed Aluminum™ Metal Cladding Details Interior Cladding		
SCALE AS NOTED							
DRAWN BY AM							
APPROVED BY SE							
ISSUE DATE 05/27/2020							